

Front View

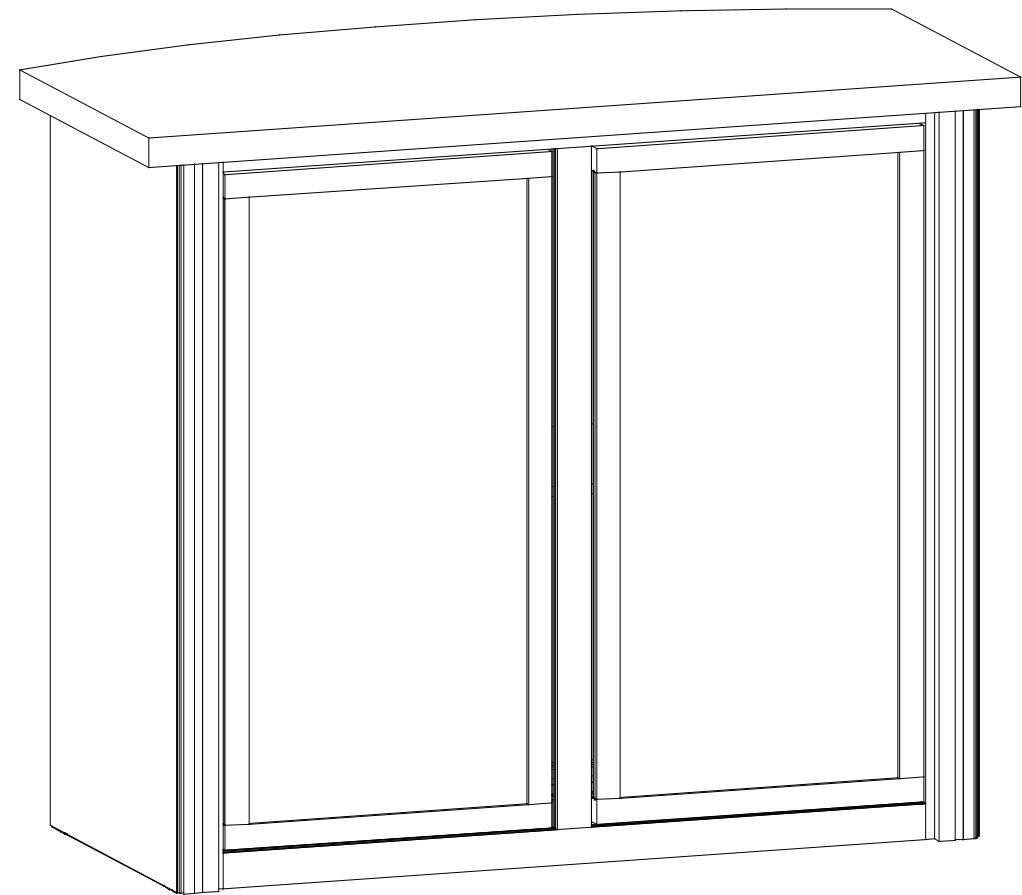

Back View

## General Setup Instructions

- Read entire setup instruction manual prior to unpacking parts and pieces.
- The setup instructions are created specifically for this configuration.
- Setup instructions are laid out sequentially in steps, including exploded views with detailed explanation for assembly.

## Cleaning & Packing

- For Cleaning Metal, Plex, & Laminate Parts: Use a **MILD NON-ABRASIVE** cleanser and soft cloth/paper towel to clean all surfaces.
- Keep exhibit components away from heat and prolonged sun exposure. **Heat and UV exposure will warp and fade components.**
- Retain all provided Packing Materials. All provided packing materials are for ease of repacking & component protection.

## Disassembly

- For loss prevention, tighten all set screws and locks during disassembly.

Assembly

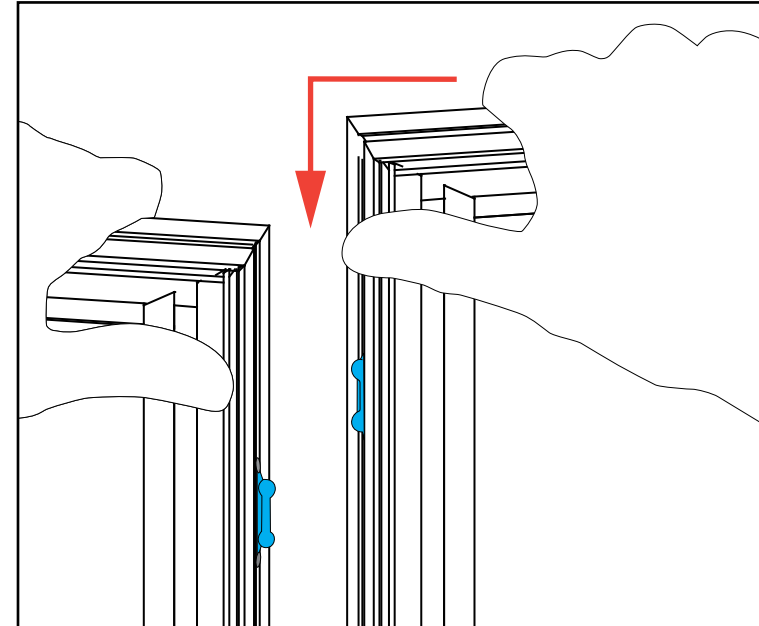

Assembly Cont'd

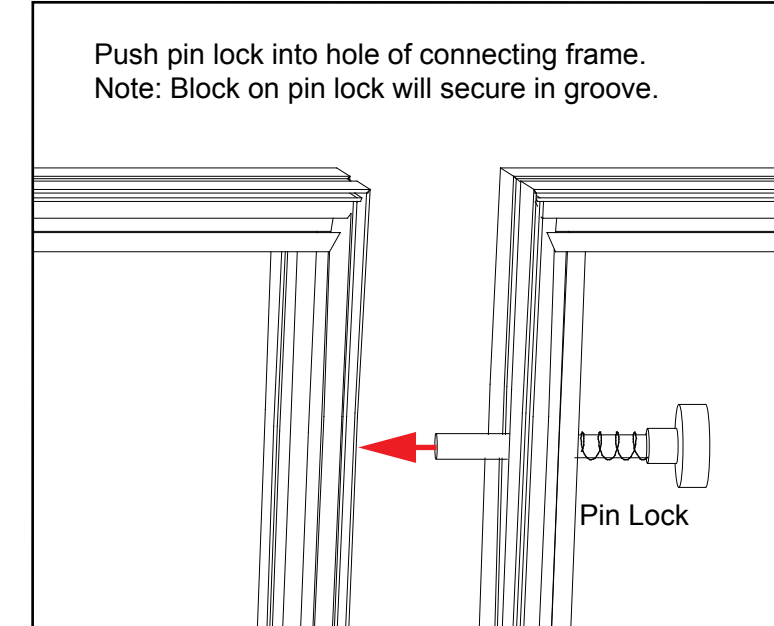

## Side-by-Side Assembly

- 1) Frames: Place frames side-by-side with one higher than the other, then slide panel down to lock panels securely together.
- 2) Corner Connectors: Repeat Step 1 for installing corner connectors to frames.

## Side-by-Side Disassembly

- 1) Pull pin lock outwards to disengage.
- 2) Pull frames upward and apart at the same time to detach.

## SEG Graphic Installation

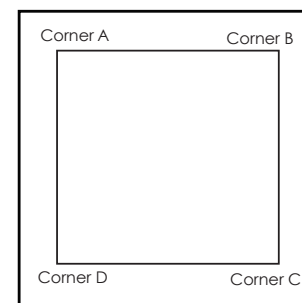

It is important to first insert graphic into each alternate corner, then to the sides of the frame. If this is not done, graphic will not fit into the frame correctly.



Step 1  
Insert corner A. Turn edge of graphic so silicon welt is perpendicular to face of graphic. Insert narrow side of welt with fabric to outside into the channel. Repeat for other side of this corner.



Step 2  
Repeat Step 1 for opposite corner C, then insert corner B, followed by corner D, to complete the installation of the corners.



Step 3  
Once all corners are inserted, press one silicon edge into channel from corners and work toward the center. Make sure welt is fully inserted into channel. Continue until all sides are done. Smooth out edges of graphic.

Graphic Removal



To remove the graphic from the frame, locate the fabric pull tab. Gently pull up on the tab to remove the fabric.

Item	Qty.	Description
1	1	38"h Gravitee Corner Post w/ Door Attachment
2	1	14.125"w x 38"h Gravitee Panel Frame
3	1	38"h Gravitee Corner Post
4	1	19"w x 38"h Gravitee Panel Frame
5	1	19"w x 38"h Gravitee Panel Frame
6	1	38"h Gravitee Corner Post
7	1	14.125"w x 38"h Gravitee Panel Frame
8	1	38"h Gravitee Corner Post w/ Door Attachment
9,9A	1,1	37.0945"w Z45 Horizontal Extrusion
10	1	34.4173"h Z45 Vertical Extrusion

Steps:

- 1) Assemble Gravitee panels and posts in numerical order, as shown, making sure Velcro is facing inward. See Gravitee Panel Assembly sheet, for instruction.
- 2) Attach horizontal extrusions [9] and [9A] between posts [2] and [7].
- 3) Attach vertical [10] between horizontals [9] and [9A].
- 4) Connect doors to posts [1] and [8]. See **Door Connection** detail.

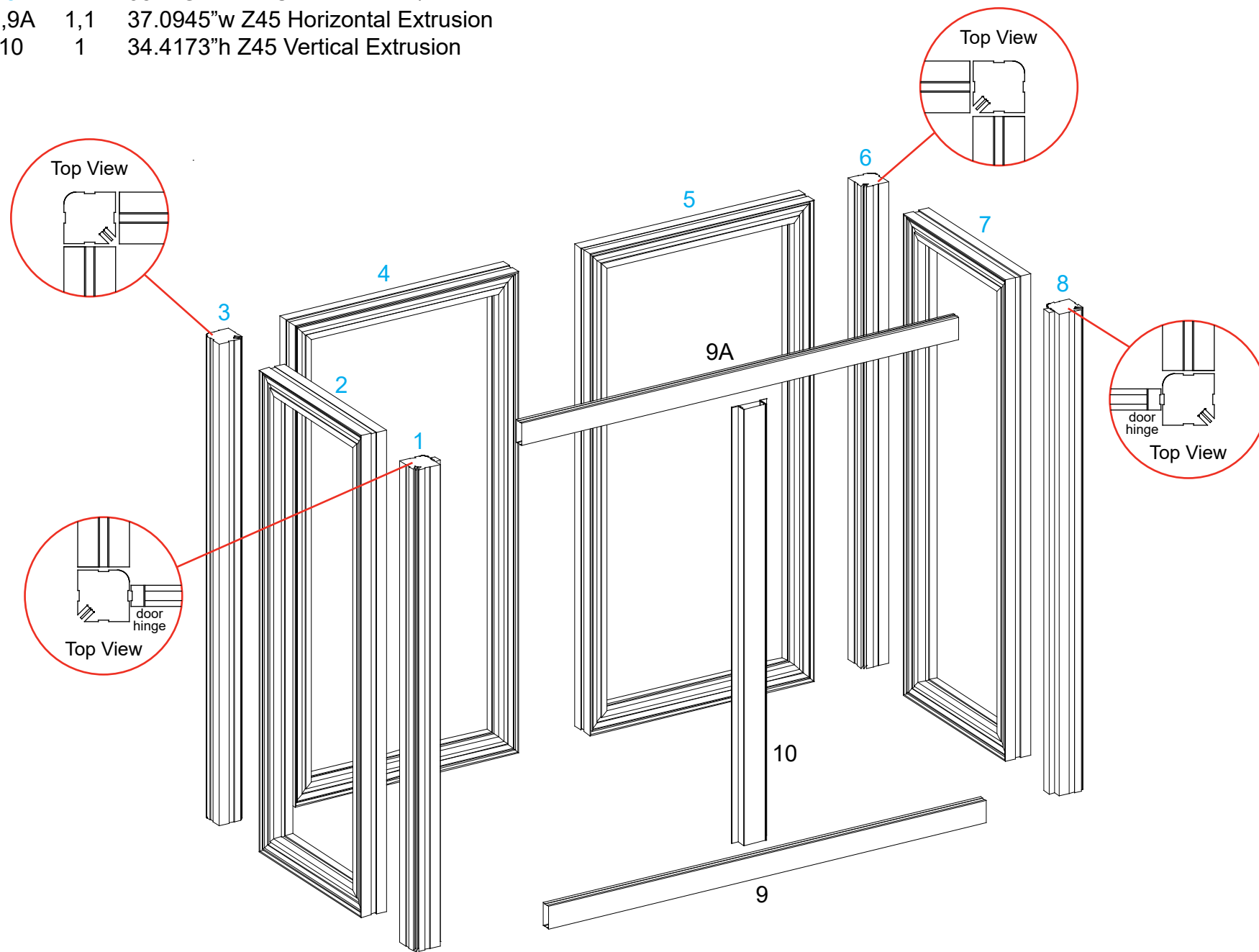
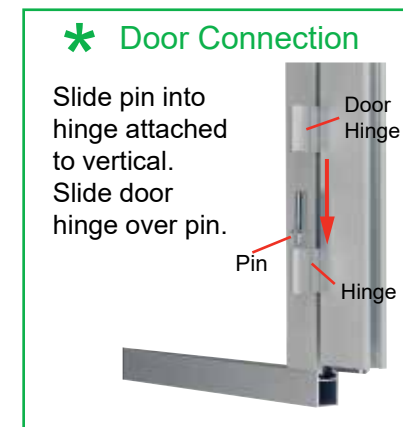

Back View

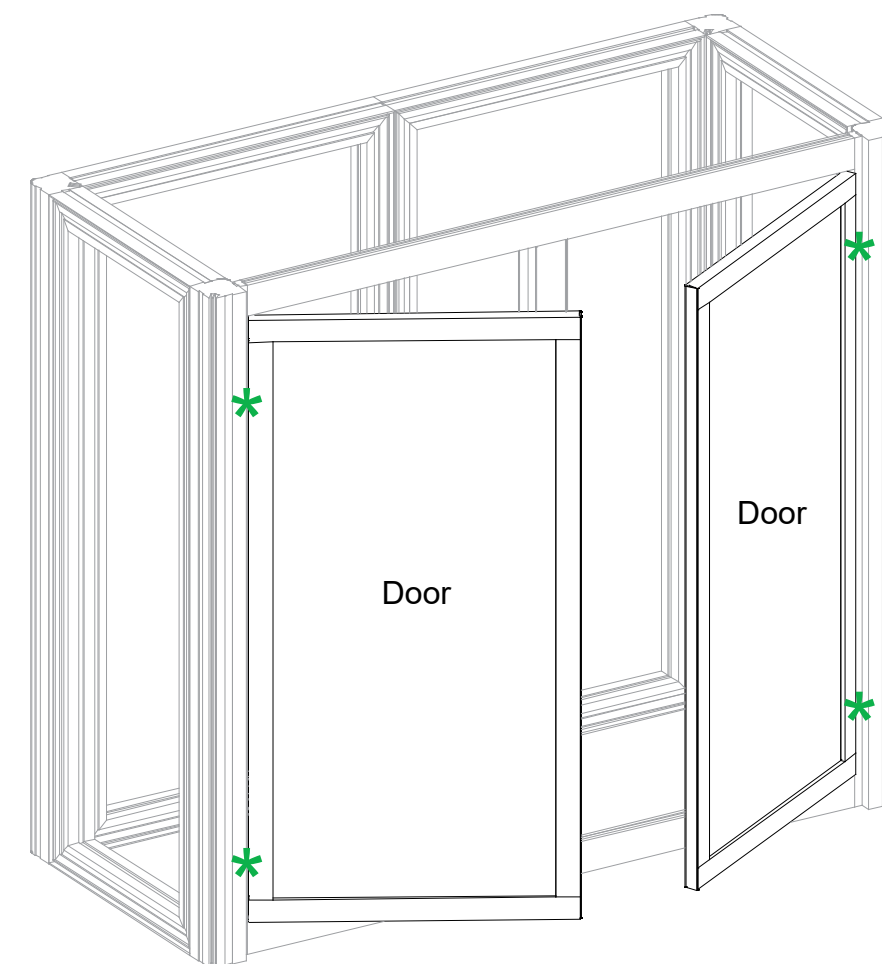

Back View

Steps:

- 1) Wrap **SEG Graphic** around front and sides of assembled counter.
- See SEG Graphic Installation sheet for instruction.
- 2) Connect shelf supports to Velcro, then place shelf on top of supports.
- 3) Lock counter top to panels [2] and [7]. See **Counter Top Lock** detail.

Keep connectors [1] [8] extrusions [9] [9A] [10] and doors assembled, when packing.

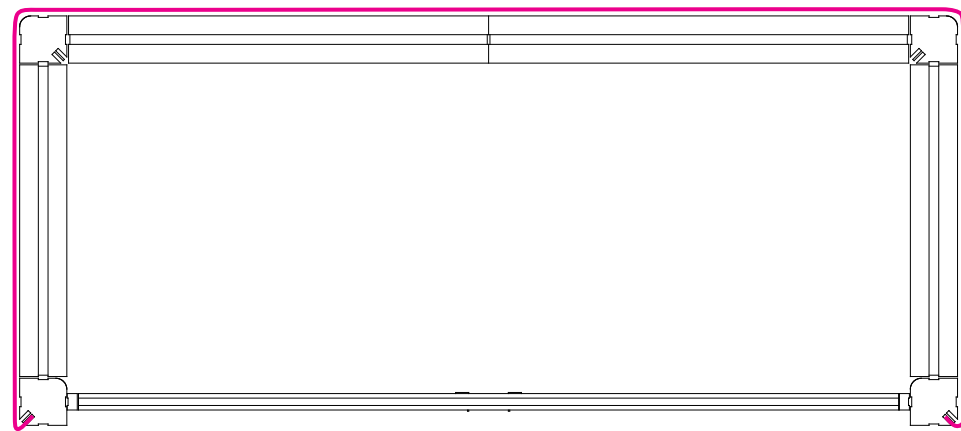

Top View

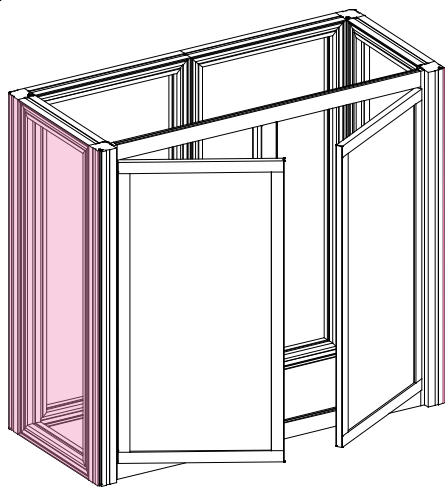

Back View

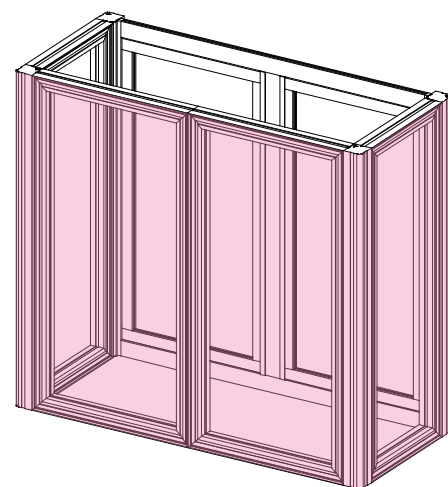

Front View

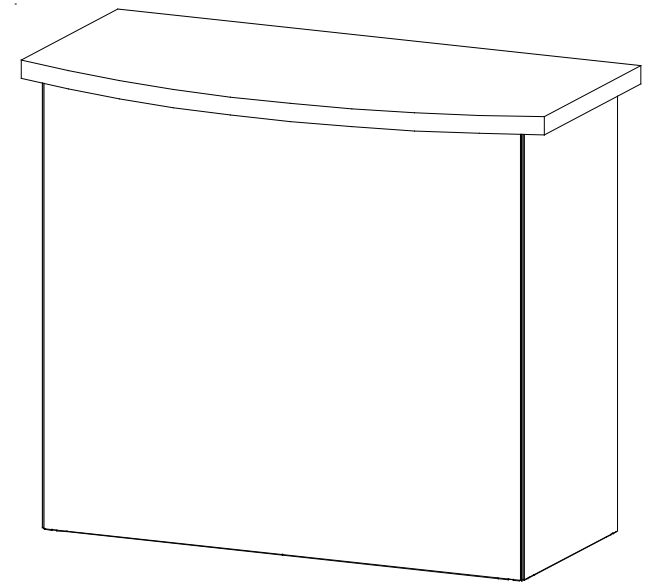
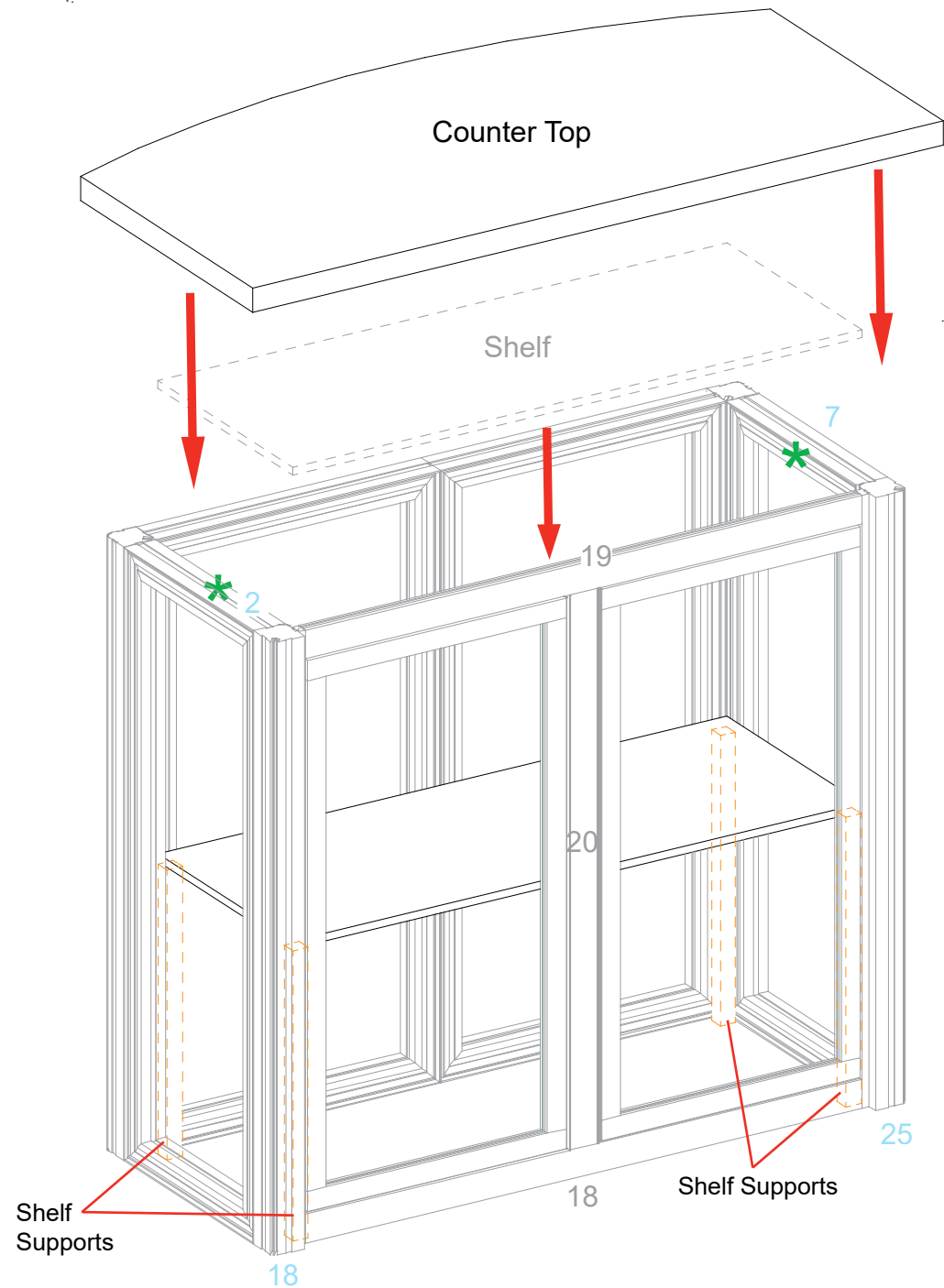

Completed Assembly

